

Users Manual

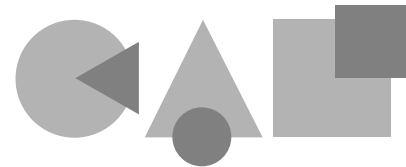

CAL 9500P Programmable Process Controller



CAL Controls

INDEX

INSTRUMENT PANEL FEATURES	2
FUNCTIONS MENU	3
GETTING STARTED	4
Initial Set-up	4
AUTOTUNE	4
Tune or tune at setpoint program	5
PROPORTIONAL CYCLE-TIME	5
Cycle-time recommendations	5
SECOND AND THIRD SETPOINTS (SP2 and SP3)	5
Error messages	6
LINEAR INPUT	6
Set-up procedure	6
FUNCTION LIST	7
Level 1	7
Level 2	7
Level 3	8
Output Options Table	8
Re-transmission	8
Level 4	9
Level A	10
PROGRAMMER	11
Function overview	11
Getting started (Programmer)	12
Program run mode	12
Display functions	12
Example program	13
Function map	14
Function list	16
Memory allocation table	17
Memory full indicator	17
Programming example	18
Program edit example	18
MECHANICAL INSTALLATION	19
DIN panel cut-out	19
Mounting	19
Cleaning	19
ELECTRICAL INSTALLATION	19
Typical application	20
Input options (diagrams)	21
Output options (diagrams)	21
INPUT SENSOR SELECTION	22
Temperature sensors	22
Linear input	22
SPECIFICATION	22
SAFETY AND WARRANTY	23

INSTRUMENT PANEL FEATURES

! This page can be photocopied and used as a visual aid and bookmark when **●** working in other parts of the manual.

Green LED:

Setpoint 1 output indicator

Green Display:

Process variable or Function/Option

Upper Red LED:

Setpoint 2 output indicator

Lower Red LED:

Setpoint 3 output indicator



Right Red LED:

Program Holdback indicator

Orange Display:

Setpoint value or program selection

ADJUSTMENTS

To enter or exit **program mode:**

Press ▲ ▼ together for 3 seconds

To scroll through **functions:**

Press ▲ or ▼

To change **levels** or **options:**

Press * ▲ together or * ▼ together

To view setpoint units:

Press *

To increase setpoint:

Press * ▲ together

To decrease setpoint:

Press * ▼ together

To reset latched alarm or tune fail:

Press ▲ ▼ together briefly

To run or Hold a program:

Press * ▼ together for 3 seconds

Notes:

If in difficulty by becoming "lost" in program mode, press ▲ and ▼ together for 3 seconds to return to display mode, check the INSTRUMENT ADJUSTMENTS above and try again.

When in program mode, after 60 seconds of key inactivity the display will revert to either *inPt : nonE* or, if the initial configuration has been completed, the measured value. Any settings already completed will be retained. During Program Configuration it is recommended that this feature is inhibited. Select *ProG StAY* in Level 4.

FUNCTIONS MENU

! This page can be photocopied and used as a visual aid and bookmark when working in other parts of the manual.

KEY ★ OR ▲ TOGETHER TO CHANGE LEVELS OR OPTIONS

LEUL4	Derivative sensitivity 0.1 to 1.0x dBct (0.5)	Display averaging off; 1 to 32 (6)	Disable AL- alarm display ; on	Disable program auto-exit Auto; 55AY	Security lock none; LE1 3; LE2 9; ALL	Change program entry point Off; on
USER-PROTECTED SETTINGS						
LEUL3	SP1 output device none; rly; 55d; AnLG	SP2 output device none; 55d; rly; (read only)	Sensor burn-out UPSC; dh; SC; 1u; 9d; 1d; 3u	Reverse outputs 1; 3d; 1; d; 1d; 1; 9r; 1; d; 9r	Reverse OP LEDs 1n; 2n; 1; 9n; 1n; 9; 1; 9r	Span adjustment 0.0 to 25% sensor full scale
CONFIGURE OUTPUT		SAFETY SETTINGS		CALIBRATION		PERFORMANCE DATA
LEUL2	Read SP1 output % 0 to 100%; read only	SP1 manual output % 0 to 100%; proportional mode only	Limit SP1 output % 100 to 0%	Limit SP2 output % 100 to 0%	Main SP2 mode none; 5; N; 1; 5; Lo; Co; J; Ep	Second SP2 mode none; L; CH; hold; L; L; ho; run
MANUAL ADJUSTMENTS			SP2 MODES		RANGING	
LEUL1	Autotune or Park Off; on; Park; At; SP	SP1 Prop band (span/ Hz) 0.1 deg to 100% sensor is (40 x 16 F)	Integral time (reset) Off; 0.1 to 60 min (5 min)	Derivative time (rate) Off; 1 to 200 sec (25 sec)	Derivative approach 0.5 to 5.0 x band (1.5)	Cycle time or on/off On/off; 0.1 to 81 sec (90 sec)
PROGRAM ENTRY (DEFAULT)			SP1 SETTINGS		SP2 SETTINGS	
LEULP	Program number 1 to 31	Run program on; hold; off; PSE	Power failure recovery mode PSE; Cont; hold	Program start value PV; SP	Setpoint ramp time units hour; 60s	Segment number 1 to 128; max.
PROGRAMMER SETTINGS						
LEULC	Instrument address 0 to 255	Baud rate 19200; 9400; 18000	Data format 18N1; 18E1; 1801	Trkx activity Off; on	Soak time interval Cont; 0.1 to 1400 (10 min)	Program re-cycle count Cont; 1 to 999
COMMS SETTINGS				SP3 ADJUSTMENTS		
LEULA	High scale 1000 -1999 to 9999	Low scale 0 -1999 to 9999	Input high 50.0 0.1 to 20.0	Input low 10.0 0.0 to 49.9	Decimate 0000 000.0 or 00.00	Main mode none dh; h; dh; Lo; band; F; sh; F; 5; Lo; Ep
LINEAR SCALING AND INPUT SETTINGS			SP3 MODES		SP3 SAFETY SETTINGS	
LEUL3	SP1 output device none; rly; 55d; AnLG	SP2 output device none; 55d; rly; (read only)	Sensor burn-out UPSC; dh; SC; 1u; 9d; 1d; 3u	Reverse outputs 1; 3d; 1; d; 1d; 1; 9r; 1; d; 9r	Reverse OP LEDs 1n; 2n; 1; 9n; 1n; 9; 1; 9r	Span adjustment 0.0 to 25% sensor full scale
CONFIGURE OUTPUT		SAFETY SETTINGS		CALIBRATION		PERFORMANCE DATA
LEUL2	Read SP1 output % 0 to 100%; read only	SP1 manual output % 0 to 100%; proportional mode only	Limit SP1 output % 100 to 0%	Limit SP2 output % 100 to 0%	Main SP2 mode none; 5; N; 1; 5; Lo; Co; J; Ep	Second SP2 mode none; L; CH; hold; L; L; ho; run
MANUAL ADJUSTMENTS			SP2 MODES		RANGING	
LEUL1	Autotune or Park Off; on; Park; At; SP	SP1 Prop band (span/ Hz) 0.1 deg to 100% sensor is (40 x 16 F)	Integral time (reset) Off; 0.1 to 60 min (5 min)	Derivative time (rate) Off; 1 to 200 sec (25 sec)	Derivative approach 0.5 to 5.0 x band (1.5)	Cycle time or on/off On/off; 0.1 to 81 sec (90 sec)
PROGRAM ENTRY (DEFAULT)			SP1 SETTINGS		SP2 SETTINGS	
LEULP	Program number 1 to 31	Run program on; hold; off; PSE	Power failure recovery mode PSE; Cont; hold	Program start value PV; SP	Setpoint ramp time units hour; 60s	Segment number 1 to 128; max.
PROGRAMMER SETTINGS						
LEULC	Instrument address 0 to 255	Baud rate 19200; 9400; 18000	Data format 18N1; 18E1; 1801	Trkx activity Off; on	Soak time interval Cont; 0.1 to 1400 (10 min)	Program re-cycle count Cont; 1 to 999
COMMS SETTINGS				SP3 ADJUSTMENTS		
LEULA	High scale 1000 -1999 to 9999	Low scale 0 -1999 to 9999	Input high 50.0 0.1 to 20.0	Input low 10.0 0.0 to 49.9	Decimate 0000 000.0 or 00.00	Main mode none dh; h; dh; Lo; band; F; sh; F; 5; Lo; Ep
LINEAR SCALING AND INPUT SETTINGS			SP3 MODES		SP3 SAFETY SETTINGS	

INITIAL SET-UP ENTRY

Range of Adjustment shown under description.

If applicable, factory settings shown in bold.

For a full description of menu functions refer to pages 7 to 10, and 16/17 in Programmer section.

Note: The letter K appears in the instrument display as the character **K**

KEY ▼ OR ▲ TO VIEW FUNCTIONS

GETTING STARTED

After power-up the controller requires programming with the following information:

Type of Sensor (See list of sensors p.22)

Operating unit °C °F bAr PSI Ph rh SSt

Allocation of Output Device to SP1/SP2 (Relay / Ssd) or analogue. SP3 is always relay.

Setpoint

When the above information has been programmed into the controller it will be operational with factory PID settings.

INITIAL SET-UP

On power-up the controller will display the self test sequence followed by the initial display *inPt* : *nonE*

1 Select input sensor.

Press and hold * and use the ▲ or ▼ buttons to scroll through the sensor selection list until the correct sensor is displayed. Release the buttons. The display will now read selected sensor type e.g. *inPt* : *tCS* (type S thermocouple).

Press ▲ once The display will now read *unit* : *nonE*

LINEAR INPUT

When **Linear Input** is selected, the display resolution of the **setpoint** and many other functions will be changed from the setting previously made at *di.SP* in Level 2, to that set at *dECP* in Level A.

It is therefore recommended that on completion of the **Initial Set-up** the **Linear Input** settings in Level A be completed before moving on to configure Levels 1, 2 and 3. (see Set-up Procedure page 6).

2 Select operating unit.

Press and hold * and use the ▲ or ▼ buttons to scroll through the unit selection list until the correct unit is displayed. Release the buttons. The display will read selected unit e.g. *unit* : °C

Press ▲ once The display will now read *SP1.d* : *nonE*

3 Select SP1 (Main setpoint output device)

Analogue output

The allocation of the analogue output to **SP1** automatically overrides the default **proportional cycle time** setting of 20 seconds. Where the analogue output is allocated to **SP2**, the default **CyC.2** setting **on/off** must be manually changed in **Level 1** to a **time proportioning** setting to enable the analogue output to operate in **proportional control mode**.

Press and hold * and use the ▲ or ▼ buttons to select from the choices *Rly*, *Ssd* or *AnLG* depending on the model supplied. SP2 and SP3 outputs will be automatically allocated. (See output options table on page 8).

4 To enter initial configuration into controller memory

Press and hold both ▲ and ▼ buttons for 3 seconds. The display will now read *PARK* and measured variable (e.g. ambient temperature 23°). *PARK* is displayed because a setpoint has not yet been entered.

To display setpoint units

Press and hold * The displays will now read *unit* (eg. °C) and 0

To enter setpoint

Press and hold * and use ▲ button to increase or ▼ button to decrease the reading and scroll to required setpoint value. (The digit roll-over rate increases with time).

THE CONTROLLER IS NOW OPERATIONAL WITH THE FOLLOWING FACTORY SETTINGS

Proportional band/Gain	10°C/18°F/100 units
Integral time/Reset	5 mins
Derivative time/Rate	25 secs
Proportional cycle-time (Typical setting for relay output)	20 secs
DAC Derivative approach control (Average setting for minimum overshoot)	1.5

Note: For more precise control or for non temperature applications where a **Linear input** transducer is being used, the controller may need to be tuned to the process. Please refer to the following section on AUTOTUNE.

AUTOTUNE

This is a single shot procedure to match the controller to the process. Select either **Tune** or **Tune at Setpoint** from the criteria given below.

The **Tune** program should be used for applications other than those listed under **Tune at Setpoint** below. The procedure will apply disturbances when the temperature or process reaches 75% of the setpoint value, causing overshoot which is monitored in order to adjust the **DAC** overshoot inhibit feature. Care should be taken to ensure that any overshoot is safe for the process.

The **Tune at Setpoint** program is recommended when:

- The process is already at setpoint and control is poor
- The setpoint is less than 100°C in a temperature application
- Re-tuning after a large setpoint change
- Tuning multi-zone and/or heat-cool applications.

Notes: **DAC** is not re-adjusted by Tune at setpoint. **Proportional Cycle Time** can be pre-selected before running the Autotune program. (see page 5).

AUTOTUNE (continued)

Hereafter in the Manual the symbol (▲▼) signifies both buttons are held pressed for 3 seconds to ENTER or EXIT Program mode.

TUNE OR TUNE AT SETPOINT PROGRAM

Enter program (▲▼) and from the display *tunE : oFF* press and hold * and press ▲ to display *tunE : on* or *tunE : At.SP* Exit program mode (▲▼).

The TUNE program will now start. The display will show *tunE* as the process variable climbs to setpoint.

Note: Avoid tuning while running a program as SP1 may be different from the target setpoint.

When the TUNE or TUNE AT SETPOINT program is complete the PID values are entered automatically. The process will rise to setpoint and control should be stable. If not, this may be because optimum cycle time is not automatically implemented. To set the cycle time see **PROPORTIONAL CYCLE-TIME**.

PROPORTIONAL CYCLE-TIME

The choice of cycle-time is influenced by the external switching device or load. eg. contactor, SSR, valve. A setting that is too long for the process will cause oscillation and a setting that is too short will cause unnecessary wear to an electro-mechanical switching device.

Factory set

To use the 20 sec factory set cycle-time no action is needed whether autotune is used or not.

To Manually Select AUTOTUNE Calculated CYCLE-TIME

When AUTOTUNE is completed, enter program (▲▼) and select *CYC.f* in Level 1. The display will read *CYC.f : 20* (the factory setting).

To view the new calculated optimum value, press and hold both * and ▼ buttons until indexing stops. The calculated value will be displayed eg. *A16*. If acceptable, exit program (▲▼) to implement this setting.

To Pre-select Automatic Acceptance of AUTOTUNE Calculated CYCLE-TIME

Before AUTOTUNE is initiated select *CYC.f* in Level1, press and hold both * and ▼ buttons until indexing stops at A -- . Exit program (▲▼) to accept calculated value automatically.

To Manually Pre-select Preferred CYCLE-TIME

Before AUTOTUNE is initiated select *CYC.f* in Level 1, press and hold both * and ▲ or ▼ buttons until indexing stops at preferred value then exit program (▲▼) to accept.

CYCLE-TIME RECOMMENDATIONS

Output Device	Factory Setting	Recommended Minimum
Internal relays	20 seconds	10 seconds
Solid state drives	20 seconds	0.1 seconds

SECOND AND THIRD SETPOINTS (SP2 and SP3)

PRIMARY ALARM MODES

Configure SP2 output to operate as an alarm from *SP2.A* in Level 2 and set the alarm setting in *SEt.2* Level 1.

Configure SP3 alarm mode *SP3.A* and setting *SEt.3* in Level A. The alarms will be individually triggered when the process value changes according to the options listed below.

dV.hi Rises above the main setpoint by the value inserted at *SEt.2/3*.

dV.Lo Falls below the main setpoint by the value inserted at *SEt.2/3*.

BAnd Rises above or falls below the main setpoint by the value inserted at *SEt.2/3*.

FS.hi Rises above the full scale setting of *SEt.2* or *SEt.3*.

FS.Lo Falls below the full scale setting of *SEt.2* or *SEt.3*.

EoP Event Output (See **Programmer** section pages 11 to 18)

SUBSIDIARY SP2 / SP3 MODES

The following additional Subsidiary alarm functions can be added to any Primary alarm configurations using the settings found at *SP2.b* in Level 2 and *SP3.b* in Level A.

LtCh Once activated, the alarms will latch and can be manually reset when the alarm condition has been removed.

Hold This feature inhibits alarm operations on power-up and is automatically disabled once the process reaches the alarm setting.

Lt.ho Combines the effects of both *LtCh* and *hold* and can be applied to any Primary alarm configuration.

SECOND SETPOINT (SP2) Proportional control output

Configure in Level 1 using *CyC.2* to select proportional cycle time and *bnd.2* to adjust proportioning band. For Heat/Cool operation see Operating Manual.

Additional in depth information on controller operation is available in the CAL 9400.PDF available for down load from www.cal-controls.com

In on-off mode, *bnd.2* adjusts SP2 hysteresis.

Alarm type	On-Off operating mode SP2 and SP3	Proportional operating mode SP2 only	Legend
Deviation BAnd	Output state LED state	Output state LED state <i>BAnd</i> : on-off mode only	 Output ON (Relay or SSd energised)
Full scale 	Output state LED state	Output state LED state	 Output OFF (Relay or SSd de-energised)
EoP Strategy	Temperature above setpoint Output state LED state	Temperature above setpoint Output state LED state	 LED ON

SP2 / SP3 OUTPUT AND LED STATUS IN ALARM CONDITION

SP2 / SP3 ALARM ANNUNCIATOR

If a Primary Alarm mode has been configured, when an alarm condition occurs the alarm annunciator **-AL-** will be displayed alternating with the process variable. The alarm together with the display, will be automatically reset as soon as the alarm condition has been cleared.

The annunciator may be disabled by selecting **no.AL: on**, in Level 4.

ERROR MESSAGES

SENSOR FAULT

Display flashes: **inPt: FAIL**

Indicates: sensor open or short circuit or linear input over-range.

Action: Check sensor/wiring/connectors

NON-VOLATILE MEMORY ERROR

Display flashes: **dAtA: FAIL**

Action: De-power briefly. Replace unit if problem persists

MANUAL POWER ERROR

Display flashes: **hAnd: FAIL**

SP1 set to on-off in **CYC.t**

Action: Select proportional mode

IMMEDIATE FAIL ON AUTOTUNE START

Display flashes: **tunE: FAIL**

Setpoint display 0

1. No setpoint entered.

Action: Enter setpoint

2. SP1 set to ON/OFF in **CyC.t**

Action: Select proportional mode

Note: To reset and clear error press **▲▼** together briefly to cancel message.

FAIL LATER DURING AUTOTUNE CYCLE

The thermal characteristics of the load exceed the Autotune algorithm limits. The failure point indicated by any display 0.0 in **tech** e.g. **Ctb = 0.0**

Action: 1. Change the conditions. e.g. raise setpoint

2. Try **tunE: At.SP**

3. If the error message persists, call local CAL representative for advice.

LINEAR INPUT

Set-up Procedure

The **4–20mA** input model converts current into voltage using an internal resistor which spreads the signal across the input range **10 to 50 mV**. using multiplier of 2.5. When using a transducer with an output less than 4–20mA, the **input maximum and minimum mV** values can be calculated using the same multiplier.

Models with **0 to 5V** input use an internal resistor to spread the signal across the input range **0 to 50 mV** using a divider of 100. Where a transducer provides a smaller output, the **input maximum and minimum** values can be similarly calculated.

Decide what scale **minimum** and **maximum** will be required, and whether the scale needs **inverting**. (See Level A; **Linear Input Scaling** for list of settings and limits, page 10).

The example below shows how a **4–20mA linear input** should be configured.

e.g. 4–20mA = 60 to 260 units where 4mA = 60 units

Follow **INITIAL SET-UP procedure** (also see page 4).

- | | |
|-------------------------------|---|
| 1. Select input sensor | Select inPt:Lin |
| 2. Select unit | Select required unit, if not available Select unit:SET |
| 3. Select SP1 output | Select from: Rly, SSd or AnLG |

Enter initial configuration into controller memory

DO NOT ENTER SETPOINT until **Linear input** has been configured in **Level A**
See **functions menu** page 3
and **functions list** page 10.

Configure Linear Input **Enter level A**

(Then using example given # above)

- | | |
|------------------------------------|--|
| 4. Enter scale maximum | Select An.hi:260 |
| 5. Enter scale minimum | Select An.Lo:60 |
| 6. Enter input maximum | Select hi.in:50.0 |
| 7. Enter input minimum | Select Lo.in:10.0 |
| 8. Enter display resolution | Select dECP:0000 (WARNING – otherwise settings marked $\frac{1}{2}$ may be altered) |

Enter Linear Input configuration into controller memory and enter setpoint.

Now configure Levels 1, 2 and 3 and if required proceed with AUTOTUNE.

Note: Any apparent calibration errors can be removed using the **ZErO** and **SPAN** adjustments in **Level 3**.

FUNCTION LIST (LEVELS 1 to 4 and A)

Note: A Functions Menu is shown on page 3.

LEVEL 1 LEVEL 1

Function **Options** *[Factory settings] shown in brackets*

SELECT AUTOTUNE (see pages 4/5)

tunE [oFF] *on* *PARk* *At.SP*
 Used to switch the Autotune feature on and off, to select *PARk* or Autotune at setpoint. *PARk* temporarily turns the output(s) off. To use select *PARk* and exit program mode. To disable re-enter program at *tunE* and select *oFF*.

SP1 OPERATING PARAMETERS

bAnd *0.1 to * C/F* *[10°C/18°F/100 units]*

SP1 proportional band/Gain or Hysteresis
 * 100% (*Hi.Sc*) sensor maximum Proportional control eliminates the cycling of on-off control. Output power is reduced, by time proportioning action, across the proportional band.

int.t *oFF* *0.1 to 60 minutes* *[5.0]*

SP1 integral time/reset
 Auto-corrects proportional control offset error

dEr.t *oFF* *1 - 200 seconds* *[25]*

SP1 derivate time/rate
 Suppresses overshoot and speeds response to disturbances

dAC *0.5 - 5.0 x bAnd* *[1.5]*

SP1 derivative approach control dAC
 Tunes warm-up characteristics, independent of normal operating conditions, by adjusting when derivative action starts during start-up (smaller dAC value = nearer setpoint).

CyC.t *A -- on.oF* *0.1 - 81 sec* *[20]*

SP1 proportional cycle-time (see pages 9/10)
 Determines the cycle rate of the output device for proportional control. Select *on.oF* for ON/OFF mode.

☼ *oFSt* *0 to * °C/°F/units* *[0]*

SP1 offset/manual reset
 * ±50% *bAnd*. Applicable in proportional and ON/OFF mode with integral disable.
Int.t : *oFF*.

SPLK [oFF] *on*

Lock main setpoint
 Locks the setpoint preventing unauthorised adjustment.

SP2 OPERATING PARAMETERS (see page 6)

Function **Options** *[Factory settings] shown in brackets*

☼ *SEt.2* *[0] to * °C/°F/units*

Adjust SP2 setpoint
 * Deviation Alarms *DV.hi*, *DV.Lo*, *bAnd* 95% sensor maximum.
 * Full scale alarms *FS.hi*, *FS.Lo* sensor range f/s

☼ *bnd.2* *0.1 - * °C/°F/units* *[2.0 °C/3.6°F 2 units]*

Adjust SP2 hysteresis or proportional band/gain
(see *CyC.2* setting)
 * 100% sensor f/s (*Hi.Sc*)

CyC.2 [on.oFF] *0.1-81 seconds*

Select SP2 ON/OFF or proportional cycle-time
 Select on.oFF for ON/OFF mode, or the cycle rate of SP2 output device for proportional mode.

LEVEL 2 LEVEL 2

MANUAL CONTROL MODES

Function **Options** *[Factory settings] shown in brackets*

SPI.P *0 to 100 % 'read only'*

Read SP1 output percentage power

hAnd [oFF] *1 to 100 % (not in ON/OFF)*

SP1 manual percentage power control
 For manual control should a sensor fail. Record typical *SP1.P* values beforehand.

PL.1 *100 to 0 % duty cycle* *[100]*

Set SP1 power limit percentage
 Limits maximum SP1 heating power during start-up and in proportional band.

PL.2 *100 to 0 % duty cycle* *[100]*

Set SP2 percentage power limit (cooling)

SP2 OPERATING MODES (see page 5)

SP2.A [nonE] *dV.hi dV.Lo bAnd FS.hi FS.Lo Cool EoP*
 Main SP2 operating mode

SP2.b [nonE] *LtCh hoLD nLin*
 Subsidiary SP2 mode: latch/sequence
 Non-linear cool proportional band

☼ Will be affected by dECP settings in Level A

LEVEL 2 CONTINUED

INPUT SELECTION AND RANGING

dI.SP [1] 0.1

Select display resolution: for display of process value, setpoint, *OFSt*, *Set.2*, *hi.SC*, *LoSC*.

⚙ *hi.SC* [sensor maximum] sensor maximum °C/°F/units
Set full scale

⚙ *Lo.SC* [sensor minimum] sensor minimum °C/°F/units
Set scale minimum (default 0°C/32°F or 0 units)

inPt Select input sensor [nonE]
(See **SENSOR SELECTION** table, page 22)

NB. If **Linear Input** selected, start configuration from **Level A**.

unit [nonE] °C °F bAr Psi Ph rh SET
Select required operating unit from above options

LEVEL 3 LEVEL 3

OUTPUT CONFIGURATION

Note 1: 'Read only' after initial configuration. *rSET ALL* full reset to factory settings required to change *SP1.d* subsequently.

Note 2: Depending on the Model, **SP1** and **SP2** may be fitted with any of three output types, **RLY**, **SSd** or **Analogue** (Specification on page 11/12) where appropriate, these must be allocated during initial configuration. **SP3** is always fitted with **RLY**.

Output Options Table

Model	SP1 Output	SP2 Output	SP3 Output
95111P	<i>RLY</i>	<i>RLY</i>	<i>RLY</i>
95001P	<i>SSd</i> <i>RLY</i>	<i>RLY</i> <i>SSd</i>	<i>RLY</i> <i>RLY</i>
95221P	<i>SSd</i>	<i>SSd</i>	<i>RLY</i>
*95X11P	<i>AnLG</i> <i>RLY</i>	<i>RLY</i> <i>AnLG</i>	<i>RLY</i> <i>RLY</i>
*95X21P	<i>AnLG</i> <i>SSd</i>	<i>SSd</i> <i>AnLG</i>	<i>RLY</i> <i>RLY</i>

* Substitute for X in table above, Analogue options B = 4–20mA, C = 0–5V, D = 0–10V

Re-transmission

* These models also offer the option of using the analogue output for **Re-transmission**. Select *bAnd* or *bnd.2* value in **LEVL 1** to equal the full range setting in **LEVL A** and if using SP1 output, set *int.t* and *dErt.t* in **LEVL 1** to off.

Example: Set-Up using a Model 95B11P to Re-transmit the 4–20 mA input, scaled 0 to 100 units. SP1 relay is used as the control output and SP2 analogue output is used for re-transmission.

Note: Read in conjunction with Linear Input Set-up Procedure on page 6.

Function **Options** [Factory settings] shown in brackets

From initial power-up;

Set *inPt nonE* to *inPt Lin*
unit nonE to *unit SET* (for example)
SP1.d nonE to *SP1.d rLY*

To scale the input, select **LEVL A**, then:

Set *dECP* to *000.0* (e.g. required resolution)
An.hi to *100.0*
An.Lo to *0.0*
hi.in to *50* (ie 20mA)
Lo.in to *10* (ie 4mA)

To align SP2 analogue re-transmission with SP1 control output, select **LEVEL 2** then:

Set *SP2.A* to *FS.hi*

And in **LEVEL 1**

Set *Set.2* to *50* (ie 50% of display range)
bnd.2 to *100* (ie 100% of display range)

Finally, set SP1 setpoint value as required for process to start.

Using SP1 output for re-transmission

Set *int.t* to off
dErt to off
rev.d to *1d.2d* to invert SP1 output
SP1 Setpoint to midscale

burn Sensor burn-out/break protection

Caution: Settings affect fail safe state.

	SP1	SP2
[uP.SC]	Upscale	Upscale
<i>dn.SC</i>	Downscale	Downscale
<i>1u.2d</i>	Upscale	Downscale
<i>1d.2u</i>	Downscale	Upscale

Retransmission range is limited to the sensor full scale value (Example RTD = 400C/752F).

⚙ Will be affected by *dECP* settings in Level A

LEVEL 3 CONTINUED

Function **Options** *[Factory settings] shown in brackets*

rEu.d **Select output modes: Direct/Reverse**
Caution: Settings affect fail safe state.

	SP1	SP2
<i>[1r.2d]</i>	Reverse	Direct
<i>1d.2d</i>	Direct	Direct
<i>1r.2r</i>	Reverse	Reverse
<i>1d.2r</i>	Direct	Reverse

Select **Reverse** on SP1 for heating and **Direct** for cooling applications.

rEu.L **Select SP1/2 LED indicator modes**

	SP1	SP2
<i>[1n.2n]</i>	Normal	Normal
<i>1i.2n</i>	Invert	Normal
<i>1n.2i</i>	Normal	Invert
<i>1i.2i</i>	Invert	Invert

SPAN *[0.0]* **to ±25% sensor maximum** *-1999–2500 in Linear*
 Sensor span adjust
 For recalibrating to align readings with another instrument e.g. External Meter, data logger.
 See Full Operating Manual (ADVANCED SETTINGS).

ZERo *[0.0]* **to ±25% sensor f/s** *-1999–2500 in Linear*
 Zero sensor error (see Sensor span adjust above).

ChEK *[oFF]* **on**
 Select control accuracy monitor

rEAD *[Var]* **hi Lo**
 Read control accuracy monitor

tECh *[Ct A]* **CT b Ct 1 Ct 2 Ct 3 Ct 4 oS 1 uS oS 2**
 Read Autotune tuning cycle data (see Operating Manual)

UEr Software version number

rSET *[nonE]* **ALL**
 Resets all functions to factory settings
Caution: This selection will lose all of the current settings.

LEVEL 4

Access to level 4 is gained through **UEr** in level 3. Press and hold ▲ and ▼ for 10 seconds.

Enter level 4 at **LoCK**, release ▲ and ▼ together. Display reads **LoCK nonE**

Program security using Lock *[nonE]*

Select from three **LoCK** options: Press and hold *, press ▲ to index.

LEV.3 locks level 3, 4, A (and C when fitted)

LEV.2 locks level 2, 3, 4, A (and C when fitted)

ALL locks all functions (including C when fitted)

Note: Any locked functions and options can still be read.

Press ▼ to access following functions.

Function **Options** *[Factory settings] shown in brackets*

ProG *[Auto]* **StAY**
 Program mode auto-exit switch
 Auto-exit returns display to normal if 60 seconds of key inactivity, select **StAY** to disable

no.AL *[oFF]* **on**
 Disable SP2 alarm annunciator -AL-
 Select on to disable -AL-

di.SS dir **1 to 32** *[6]*
 Display sensitivity
dir = direct display of input **1** = maximum, **32** = minimum sensitivity

dEr.S **0.1 to 1.0** *[0.5]*
 Derivative sensitivity

SEt.L *(oFF)* **on** Remember next menu exit point and use as new menu entry point, except when exit is in Level 1.

LEVEL P

See PROGRAMMER Section, page 11.

LEVEL C

COMMS SETTINGS; visible only when Comms option fitted.

Additional in depth information on controller operation is available in the APPGUIDE.PDF available for down load from www.cal-controls.com

Will be affected by dECP settings in Level A

LEVEL A	LEVEL A
---------	---------

Function	Options	[Factory settings] shown in brackets
----------	---------	--------------------------------------

Linear Input Scaling

Please read in conjunction with Linear Input Set-up Procedure on page 6.

⚙️ An.hi	-1999 to 9999	[1000]
Adjusts required scale maximum		

⚙️ An.Lo	-1999 to 9999	[0]
Adjusts required scale minimum		

hi.in	0.1 to 50.0	[50.0]
Configure input maximum		

Lo.in	0.0 to 49.9	[10.0]
Configure Input minimum		
This setting must be at least 0.1 less than the setting for hi.in above.		

Note: Refer to Linear Input conversion factors detailed in the Set-up Procedure on page 6.

dECP	000.0 to 00.00	[0000]
Scale resolution		

NB. Once the **Linear Input** option has been selected, the setting here over-rides the scale resolution setting **di.SP** in Level 2 and will affect the following display readings:

Level A:	An.hi; An.Lo; Set.3; hYS.3
Level 1:	bAnd; ofSt; SPrr; SET2; bnd.2
Level 2:	hiSC; LoSC
Level 3:	SPAn; ZERo; rEA; tECh

SP3 SETTINGS

SP3.A [nonE]	dV.hi dV.lo bAnd FS.hi FS.Lo EoP
Main SP3 operating mode	

SP3.b [nonE]	LtCh hoLd Lt.ho
Subsidiary SP3 operating mode	

SEt.3	0 to 2500	[0]
SP3 setpoint adjustment		

hyS.3	0.1 to 100% of hiSC	[20]
Set SP3 hysteresis		

Function	Options	[Factory settings] shown in brackets
brn.3 [uPSC]	uPSC or dnSC	
Sensor burn-out / break protection		
Select upscale or downscale		
rEV.3 [3d]	3d or 3r	
Reverse SP3 output mode		
Select direct or reverse operation		

PROGRAMMER

INDEX

Function overview	11
Getting started	12
Program run mode	12
Display functions	12
Example program	13
Function map	14
Function list	16
Memory allocation table	17
Memory full indicator	17
Programming example	18
Program edit example	18

FUNCTION OVERVIEW

The Programmer function in Level P enables the Model 9500P to control applications needing **Setpoint** changes over time. Examples of this are **Ramp** changes where a gradual **Rate** of change can be set, or **Step** changes which are instantaneous. These can be separated by **Soak** periods during which the process is held at a constant value. Each individual time interval of the program or **Segment**, together with its associated moving setpoint value can be stored as a unique **Program** and for example be represented by the diagram below.

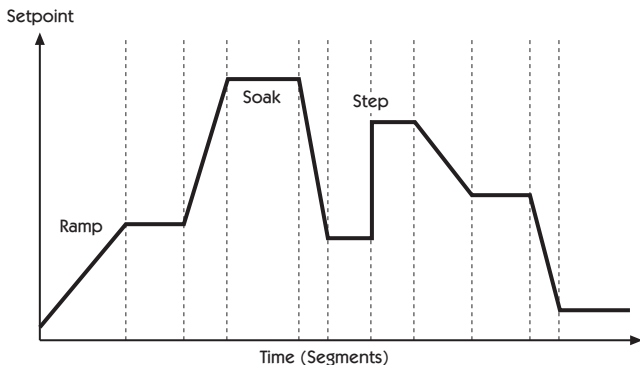

In addition to those settings that determine the segment profile, it is also necessary to set **program start** values, together with the preferred **ramp rate time units** for each individual program.

At the end of a sequence, a Program can be arranged to repeat (**Loop**), either a specified number of **Cycles**, or continuously. Only one **Loop** can be included in a **Program**. When the program is running, the **Display** indicates progress through the sequence of segments, and can additionally be interrogated for further segment information.

It is also possible to **CALL** an already existing program as a sub program that can be inserted as a segment of another program.

To speed up **Program** configuration, several **Edit** functions have been provided so that individual **Segments** and **Programs** may be **Deleted** or **Inserted**, and an entire **Program** may be **Copied** and then **Pasted** into another that it will replace.

For safety reasons, three modes of recovery from a power failure are available. These either automatically **Re-start** the Program from the beginning, **Continue** it from where it stopped, or **Hold** it waiting for a user re-start.

Either one or both of the two auxiliary outputs can be configured as **Event** outputs. Engaging the **Holdback** feature will temporarily halt Setpoint ramping to allow the process temperature to catch up should it deviate by more than a pre-set amount during a **Ramp** segment.

To afford maximum programming flexibility, memory is allocated dynamically, and not pre-allocated. This allows the user the freedom to configure a small number of long programs or a larger number of shorter ones, up to the permitted maximum of 126 Segments per program, and a limit of 31 Programs. Should these limits be exceeded, or the Programmer memory become fully used, the display will read **ProG FULL**. Programs can be planned using the **Memory Allocation Table** which details the memory requirements of individual segment types. During configuration a check can be kept on memory usage by interrogating the **USED** feature of the display to give an instant reading of 'percentage memory used'.

Finally, once a program has been configured, it can be run from the **run off/on/hold** controls in Level P, and in addition a quick access **run/hold** toggle is directly available from the front panel.

The Programmer **Functions List** describes the full range of available **Settings** for each **Programmer Function** together with their display mnemonic. The **Model 9500P** is supplied with a suite of **Factory Settings** for each **Function**. These are shown in bold type.

The Functions Map illustrates the relationship between the **Functions** and their **Settings** and provides a guide to the **Keying Operations** required to navigate around the menu when configuring or running a Program.

GETTING STARTED (PROGRAMMER)

For users with previous experience of configuring programmers, the **Function List** and **Functions Map** on pages 14/15 and 16/17 respectively will be reasonably self explanatory. The Functions and their Settings are grouped to maximise speed of Programming.

New users should take a short time to study the following before starting to configure the first program, and may wish to take on board the following tips and suggestions.

Program Mode Exit switch (*ProG/Auto*) Program Level 4.

This standard feature of the Model 9500 causes automatic exit from program mode after sixty seconds of Key inactivity. It is highly recommended that this setting be disabled and changed to *ProG/StAy* to ensure that adequate time is available for making unfamiliar adjustments. (see page 9). It may also be useful at this point to consider the setting also on Level 4, *SEt.L* that enable the Programmer menu entry point to be changed from it's default position to the point of last exit. (see page 9).

Program Parameter List

Listing the required **Program Settings** and **Parameter Values** segment by segment beside each **Setting/Segment Number**, and **Program Display Mnemonic** will reduce the risk of programming mistakes during the learning period.

Memorise Basic Key Functions

Use the Function Map on pages 14 and 15 to become familiar with the following Menu Navigation principles.

Hold both ▲ and ▼ for three seconds to enter or exit Program Mode.

Key either ▲ or ▼ to view Functions (follow horizontal arrows).

Key either ★▲ or ★▼ to view or change settings (follow vertical arrows).

Key ★ and hold for three seconds to confirm Edit Functions. †

Note: **Factory Settings** appear in the lower display in each of the **Functions** illustrated in the **Function Map**.

Program configuration

When the PROGRAMMER function is entered at **LEVL P**, the Programmer is automatically presented in Configuration Mode, and the instrument display can be used to access and adjust the various **FUNCTIONS** as they appear in the **FUNCTIONS MAP** illustrated on pages 14 and 15.

Program Run Mode

To run a Program from **LEVL P**,
Press ▲ once, then use ★▲ to select the required program number from the *ProG* list.
Press ▲ again once then use ★▲ to select the run/on option.
Press ▼▲ and hold for three seconds to exit configuration mode and run the program.

Run/Hold Toggle Feature

Press ★▼ and hold for 3 seconds to **hold** the program.
Press ★▼ again and hold for 3 seconds to **run** the program.

Note: Level P is 'read only' while a program is active.

To run a stopped program again press and hold the ★▼ to toggle RUN ON/OFF/ON again.

DISPLAY FUNCTIONS

Once the program is running, the display automatically tracks the progress of the program as it indexes through it's sequence of segments. When it concludes it's final instruction, the upper display alternates **StoP** with the **Process Value** and the lower display reverts to the instrument **SP1 Setpoint**.

RAMP

The upper display alternates between *SPr* and the moving **Process Value** while the lower display shows **Target Setpoint**. If **Holdback** is activated, the decimal point in the lower right corner of the upper display will be illuminated.

SOAK

The upper display alternates between *SoAK* and the **Process Value**. The lower display reads the **Target Setpoint** of the current segment.

STEP (not displayed)

As this involves an instantaneous change of the **Target Setpoint**, this segment occupies zero time and the program immediately moves to the next segment. The lower display then registers the new **Target Setpoint**, with the upper display alternating in either *SPr* or *SoAK* mode according to the segment configuration.

HOLD

If the program is paused in **HOLD**, the upper display alternates between *hold* and the **Process Value**, while the lower display indicates the **Target Setpoint** of the current segment.

User Displays

With the program running, a further display function is available at any time.

Press and hold ★	Display shows Program Number
Also press ▲ once	Display shows Segment Number
Press ▲ again	Display shows number of loops completed if a loop function has been set.
Press ▲ again	Upper display reads <i>t.SP</i>
	Lower display shows moving Ramp setpoint
Or if in Soak Segment	Upper display reads <i>Sint</i> (Soak interval)
	Lower display reads remaining Soak time
Release ★	To return display to Program Run mode

† See examples of EDIT procedures (page 18) and example of a configured Program on page 13.

PROGRAMMER FUNCTION MAP

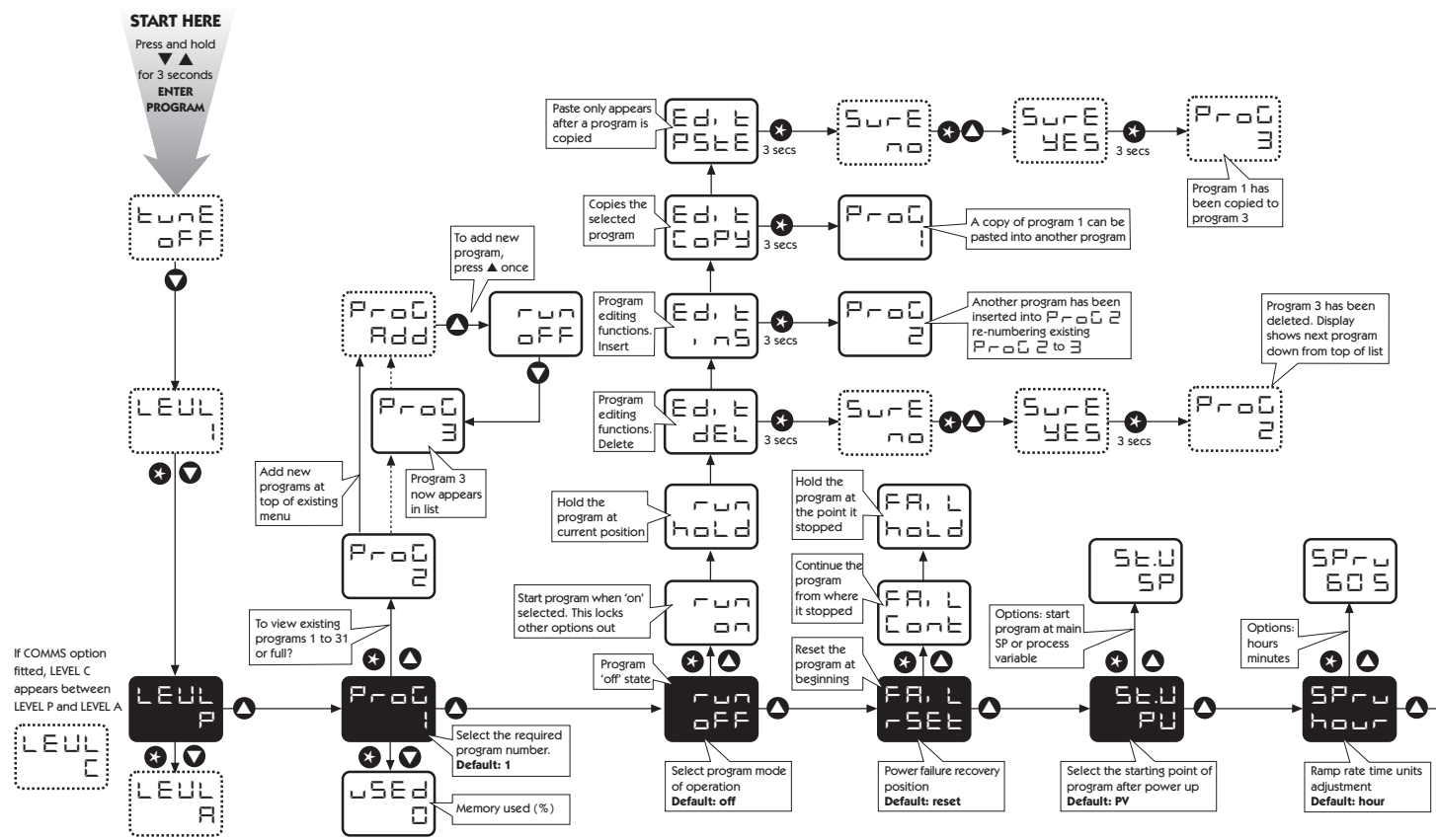

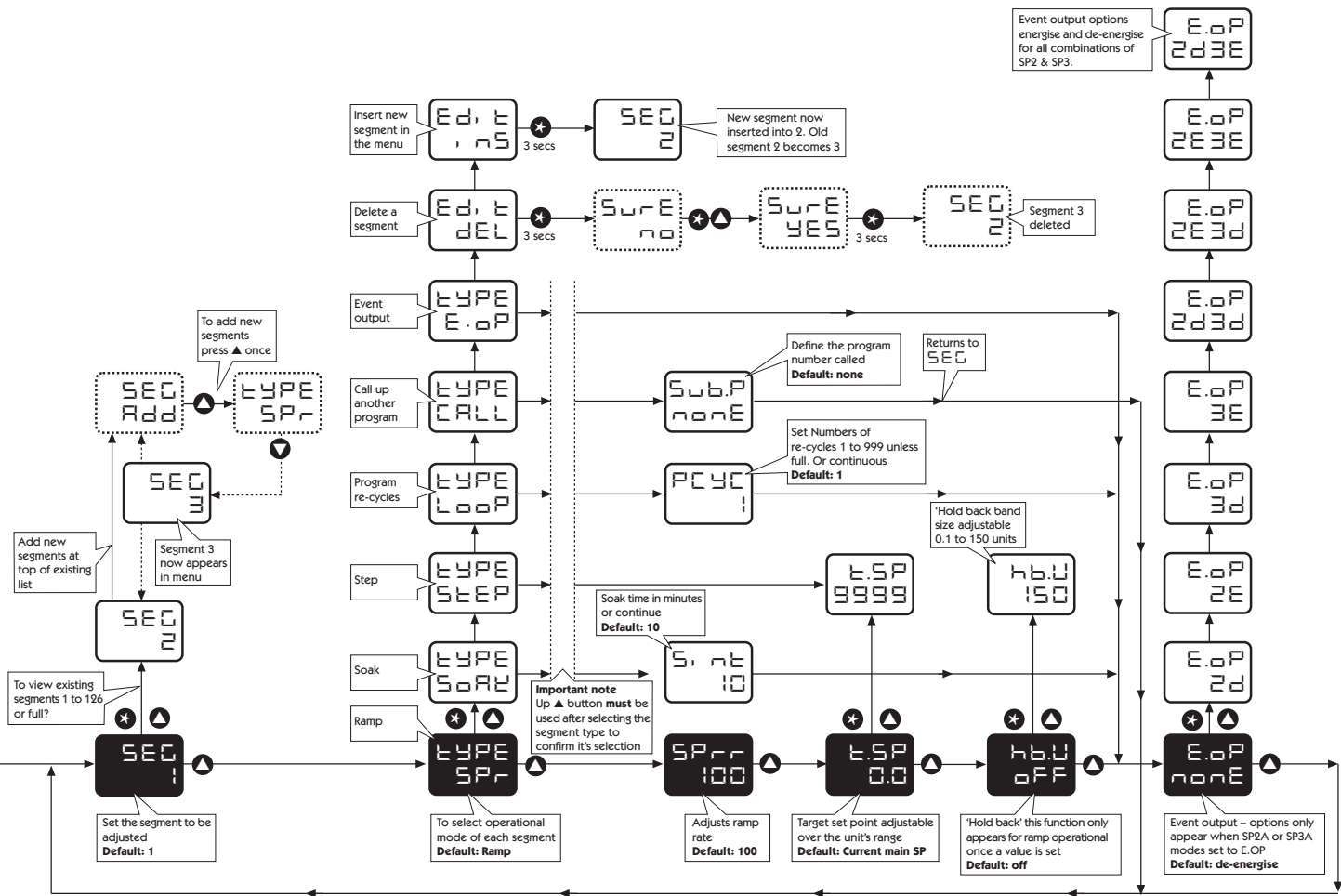

FUNCTION LIST (LEVEL P) PROGRAMMER

LEVEL P LEVEL P

Access Level P from Level 1. Press and hold * ▼

Function	Settings [Factory settings] shown in brackets	Press ▲ or ▼ to change	Press * ▲ or * ▼ to change
ProG	Program number	[1]	Add new programs (1 to 31)
run	Run Program	[oFF]	Program not running
		on	Run program
		hoLd	Pause program
		Edit dEL	Delete program † ❖
		Edit inS	Insert new program †
		Edit CoPy	Copy another program †
		Edit PStE	Paste copied program †
Fail	Power failure recovery mode	[rSEt]	Reset to program start
		Cont	Continue from interruption
		hoLd	Hold at interruption (User re-start)
St.V	Program start value	[PV]	Process value
		SP	Setpoint value
SPru	Ramp rate time units	[hour]	Ramp rate adjust in hours
		60 s	Ramp rate adjust in minutes
SEG	Segment number	[1]	Add new segments (1 to 126) *

Function	Sub-functions	Settings [Factory settings] shown in brackets
	Press ▲ or ▼ to change	Press * ▲ or * ▼ to change
Type	Define segment type	SPr
		SPrr
		t.SP
		hb.u
		SoAK
		Sint
		StEP
		Loop
		PCYC
		CALL
		Sub.P
		Edit dEL
		Edit inS

Ramp to next target setpoint [100] Setpoint ramp rate Units per hour/minute (0-9990) (as set at **SPru** above)

(Segment target setpoint) adjustable over instrument's configured range

Hold back [oFF] sets the permitted band size for the measured value to deviate from the ramp setpoint before the program is 'held back' waiting for the measured value to catch up. (0.1 to 150 units)

Hold setpoint for pre-set time [10] Soak time, adjust in minutes (cont.-1440) x 0.1

Step to new target setpoint (Set **tSP** as above)

Re-cycle program [1] Set number of program loops up to 999, or continuous loop *

Call up another program by number to import into this program (**nonE**) Number of Program called at **Call** above

Delete segment † ❖

Insert new segment †

† See examples of EDIT procedures (page 18)

❖ Deleting a Program automatically re-numbers those programs with higher numbers

* Until memory full. See page 11 for further explanation and memory allocation table on page 17.

Function	Settings <i>[Factory settings] shown in brackets</i>	
	Press ▲ or ▼ to change	Press ✱ ▲ or ✱ ▼ to change
E.oP Event output	[nonE]	Function can be applied to each segment independently to trigger an output at the start of that segment for the duration of that segment. Setting blocked unless either or both outputs SP2A or SP3A have been configured as an Event Output in Level 2 or Level A respectively.
	2d	SP2A de-energised to mark event
	2E	SP2A energised to mark event
	3d	SP3A de-energised to mark event
	3E	SP3A energised to mark event
	2d.3d	SP2A and SP3A de-energised to mark event
	2E.3d	SP2A energised SP3A de-energised to mark event
	2E.3E	SP2A and SP3A energised to mark event
	2d.3E	SP2A de-energised SP3A energised to mark event

To Return to:

LEVL P Press and hold ▼

To Read % Programmer memory used:

USED Press ✱ and ▼ together in LEVL P / ProG 1
1–100%

Memory Allocation Table

Segment type	Memory required
Ramp	4 Bytes
Ramp with Holdback	5 Bytes
Soak	2 Bytes
Step	3 Bytes
Loops (1–3)	1 Byte
Loops (4+)	2 Bytes
Call	1 Byte
Event Output	1 Byte
Program Header	1 Byte

Maximum capacity: 351 Bytes
 31 Programs
 126 Segments

Examples:

- | | |
|---|-----------|
| 1. 1 program of 58 Ramps and 58 Soaks | 349 Bytes |
| 2. 4 programs of 14 Ramps and 14 Soaks | 340 Bytes |
| 3. 31 programs of 2 Ramps and 1 Soak | 341 Bytes |
| 4. 2 programs of 10 Ramps, 10 Soaks, 2 Steps and 1 loop | 136 Bytes |

Memory Full Indication

Should the programmer memory capacity be reached during program configuration, the display will show 'FULL'

MECHANICAL INSTALLATION

The Controller is designed to be sleeve mounted in a 1/16 DIN panel cutout with only the front panel rated to NEMA4/IP66, provided that:

- the panel is smooth and the panel cutout is accurate;
- the mounting instructions are carefully followed.

DIN PANEL CUTOUT

1/16 DIN: 45.0mm +0.6 / -0.0 wide, 45.0mm +0.6 / -0.0 high

Maximum panel thickness 9.5mm

Minimum spacing 20mm vertical, 10mm horizontal

MOUNTING

To mount a Controller proceed as follows:

- 1 Check that the controller is correctly orientated and then slide the unit into the cutout.
- 2 Slide the panel clamp over the controller sleeve pressing it firmly against the panel until the controller is held firmly.
- 3 The controller front bezel and circuit board assembly can be unplugged from the sleeve. Grasp the bezel firmly by the recesses on each side and pull. A screwdriver can be used as a lever if required.
- 4 When refitting the bezel assembly it is important to press it firmly into the sleeve until the latch clicks in order to compress the gasket and seal to NEMA4X/IP66.

CLEANING

Wipe down with damp cloth (water only)



CAUTION: The controller should be isolated before removing or refitting it in its sleeve. Live circuits can hold a charge for short periods after isolation from voltage supply. Electrostatic precautions should be observed when handling the controller outside its sleeve.

DIMENSIONS

Bezel*		Behind Panel		Overall Length	Behind panel Length*
Width	Height	Width	Height		
51.0	51.0	44.8	44.8	116.2	106.7

Dimensions in mm

* includes gasket

ELECTRICAL INSTALLATION

(See important Safety Information page 20)

OUTPUT DEVICES

WARNING:

Three types of output device may be factory fitted to the controllers, and users must choose how to allocate these to outputs SP1 and SP2. (SP3 is always RLY). Check the model number and output configuration against the **Output Options Table** on page 8 before wiring the instrument and applying power.

1 Solid state relay drive (SSd1/SSd2)

6Vdc (nominal) 20mA max.

To switch remote SSR (or logic)

2 Miniature power relay (rLY/rLY1/rLY3)

2A/250V AC resistive, Form A/SPST contacts.

3 Analogue Output (AnLG) (isolated)

Specify; 4–20mA 500Ω max +/- 0.1% fs typical

0–5Vdc 10mA (500Ω min) +/- 0.1% fs typical

0–10Vdc 10mA (1KΩ min) +/- 0.1% fs typical

SUPPLY VOLTAGE

100–240V 50–60HZ 6.0VA (nominal)

+/- 10% maximum permitted fluctuation

WIRING THE CONNECTOR

Prepare the cable carefully, remove a maximum of 8mm insulation and ideally tin to avoid bridging. Prevent excessive cable strain. Maximum recommended wire size: 32/0.2mm 1.0mm² (18AWG).

INDUCTIVE LOADS

To prolong relay contact life and suppress interference it is recommended engineering practice to fit a snubber (0.1uf/100 ohms) between relay output terminals.

CAUTION:

Snubber leakage current can cause some electro-mechanical devices to be held ON. Check with the manufacturers specifications.

EN61010 - /CSA 22.2 No 1010.1 92

Compliance shall not be impaired when fitted to the final installation.
Designed to offer a minimum of Basic Insulation only.

The body responsible for the installation is to ensure that supplementary insulation suitable for Installation Category II or III is achieved when fully installed.

To avoid possible hazards, accessible conductive parts of the final installation should be protectively earthed in accordance with EN61010 for Class 1 Equipment.

Output wiring should be within a Protectively Earthed cabinet.

- * Sensor sheaths should be bonded to protective earth or not be accessible.

Live parts should not be accessible without the use of a tool.

When fitted to the final installation, an IEC/CSA APPROVED disconnecting device should be used to disconnect both LINE and NEUTRAL conductors simultaneously.

A clear instruction shall be provided not to position the equipment so that it is difficult to operate the disconnecting device.

* EMC Immunity

EMC immunity may be improved by fitting large Ferrite cores around the sensor cables at the point where they enter the cabinet and an earth bond is recommended.

TYPICAL APPLICATION

In this example the load temperature is monitored by a temperature transducer/transmitter which provides a 4–20mA input signal to the controller. The 4–20mA output has been allocated to SP1 to drive an SCR power controller providing a phase angle controlled output to the heater.

F1 Fuse: 1A time lag type to IEC127. CSA/UL rating 250Vac

F2 Fuse: High Rupture Capacity (HRC) Suitable for maximum rated load current

S1 Switch: IEC/CSA/UL Approved disconnecting device.

TYPICAL APPLICATION

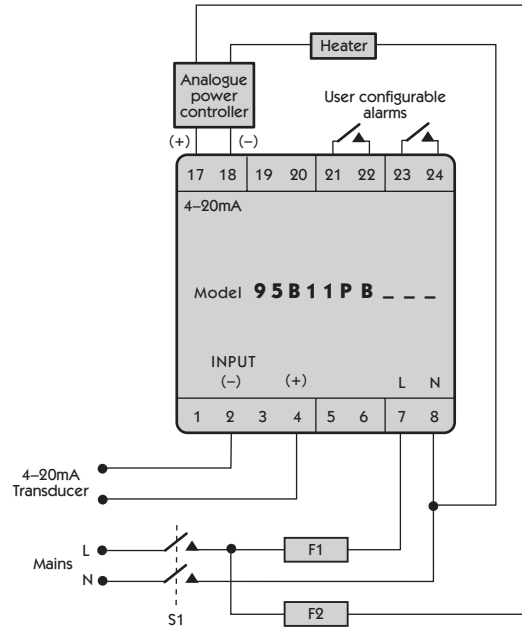

INPUT OPTIONS

OUTPUT: HARDWARE OPTIONS & TERMINATIONS

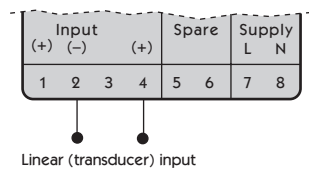
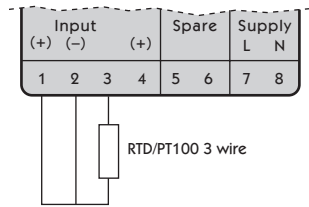
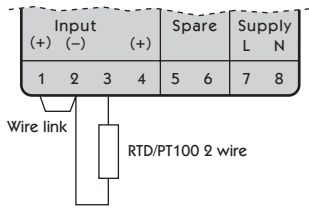
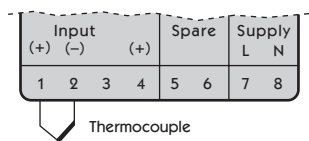

Standard Input Code

95 --- PA

Linear Input Codes

- 95 --- PB = 4-20mA
- 95 --- PC = 0-5V
- 95 --- PD = 0-10V

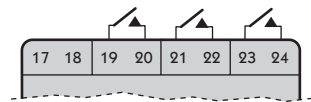

Model Output Codes

95111P

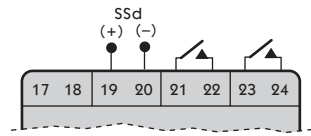

95001P

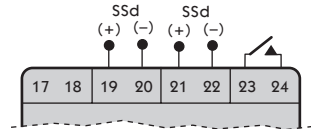

95221P

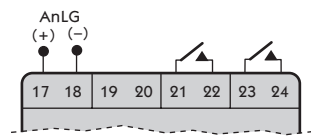

- 95B11P = 4-20mA
- 95C11P = 0-5V
- 95D11P = 0-10V

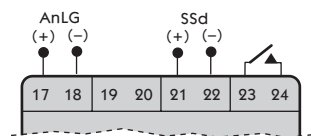

- 95B21P = 4-20mA
- 95C21P = 0-5V
- 95D21P = 0-10V

Relay = 1 SSd = 2 Analogue = B/C/D

The analogue output always replaces the output on terminals 19 & 20.

INPUT SENSOR SELECTION

Temperature sensors

Thermocouples	Description	Sensor range	Linearity
tC b	Pt-30%Rh/Pt-6%Rh	0 to 1800 °C	2.0 *
tC E	Chromel/Con	0 to 600 °C	0.5
tC J	Iron/Constantan	0 to 800 °C	0.5
tC K	Chromel/Alumel	-50 to 1200 °C	0.25*
tC L	Fe/Konst	0 to 800 °C	0.5
tC n	NiCrosil/NiSil	-50 to 1200 °C	0.25*
tC r	Pt-13%Rh/Pt	0 to 1600 °C	2.0*
tC s	Pt-10%Rh/Pt	0 to 1600 °C	2.0*
tC t	Copper/Con	-200 / 250 °C	0.25*
Resistance thermometer rtd 2/3 wire	Pt100/RTD-2/3	-200 / 400 °C	0.25*

- Notes:**
- Linearity: 5-95% sensor range
 - * Linearity B:5° (70° - 500°C) K/N:1° >350°C
exceptions: R/S: 5° <300°C T:1° < -25° >150°C
RTD/Pt100: 0.5° <-100°C

Linear input (specification)

Maximum recommended display resolution: 1mV / 500°

Linear Input	Typical accuracy	Range
0-50mV	+/- 0.1%	-199 to 9999
4-20mA	+/- 0.1%	-199 to 9999
0-5	+/- 0.1%	-199 to 9999
0-10V	+/- 0.1%	-199 to 9999

SPECIFICATION

Thermocouple

9 types
Standards: IEC 584-1-1:EN60584-1
CJC rejection: 20:1 (0.05°/°C) typical
External resistance: 100Ω maximum

Resistance thermometer

RTD-2/Pt100 2 wire

Standards:

IEC 751:EN60751
(100Ω 0°C/138.5Ω 100°C Pt)
0.2mA maximum

Bulb current:

0 to 50mV

Linear process inputs see *Linear input (specification)*

mV range:

0 to 50mV

Applicable to all inputs SM = sensor maximum

Calibration accuracy:

±0.25% SM ±1°C

Sampling frequency:

input 10Hz, CJC 2 sec.

Common mode rejection:

Negligible effect up to 140dB, 240V, 50-60Hz

Series mode rejection:

60dB, 50-60Hz

Temperature coefficient:

50ppm/°C SM typical

Reference conditions:

22°C ±2°C, rated voltage after 15 minutes
settling time.

Output devices check configuration

SSd1 and SSd2:

solid state relay driver: To switch a remote SSR
6Vdc (nominal) 20mA non-isolated

Miniature power relay:

form A/SPST contacts (AgCdO)

rLY, rLY1 and rLY3:

2A/250ac resistive load

Analogue output:

4-20mA 500Ω max +/- 0.1% fs typical
0-5Vdc 10mA (500Ω min) +/- 0.1% fs typical
0-10Vdc 10mA (1KΩ min) +/- 0.1% fs typical

General

Displays:

Upper, 4 Digits, high brightness
green LED. 10mm (0.4") high.

Lower, 4 Digits, high brightness Orange LED
9mm (0.35") high

Digital range -199 to 9999

Hi-res mode -199.9 to 999.9

LED output indicators - flashing

SP1 square, green; SP2/SP3 round, red

Keypad:

3 elastomeric buttons

Environmental

Humidity:

Max 95% (non condensing)

Altitude:

up to 2000M

Installation:

Categories II and III

Pollution:

Degree II

Protection:

NEMA 4X, IP66 (Front panel only)

EMC emission:

EN50081-1 FCC Rules 15 subpart J Class A

EMC immunity:

EN50082-2

Ambient:

0-50°C (32-130°F)

Mouldings:

flame retardant polycarbonate

Weight:

180g (6.4 oz)

SAFETY AND WARRANTY INFORMATION

INSTALLATION



Designed for use:

UL873 - only in products where the acceptability is determined by Underwriters Laboratories Inc.

EN61010-1 / CSA 22.2 No 1010.1 - 92

To offer a minimum of Basic Insulation only.

Suitable for installation within Category II and III and Pollution Degree 2.

SEE ELECTRICAL INSTALLATION Page 19

It is the responsibility of the installation engineer to ensure this equipment is installed as specified in this manual and is in compliance with appropriate wiring regulations.

CONFIGURATION

All functions are front selectable, it is the responsibility of the installing engineer to ensure that the configuration is safe. Use the program lock to protect critical functions from tampering.

ULTIMATE SAFETY ALARMS

Do not use SP2/SP3 as the sole alarm where personal injury or damage may be caused by equipment failure.

WARRANTY

CAL Controls warrant this product free from defect in workmanship and materials for three (3) years from date of purchase.

- 1 Should the unit malfunction, return it to the factory. If defective it will be repaired or replaced at no charge.
- 2 There are no user-servisable parts in this unit. This warranty is void if the unit shows evidence of being tampered with or subjected to excessive heat, moisture, corrosion or other misuse.
- 3 Components which wear, or damage with misuse, are excluded e.g. relays.
- 4 CAL Controls shall not be responsible for any damage or losses however caused, which may be experienced as a result of the installation or use of this product.

CAL Controls liability for any breach of this agreement shall not exceed the purchase price paid E. & O.E.

Copyright CAL Controls Ltd. 2000

Not to be reproduced without prior written permission from CAL Controls Ltd. Whilst every effort has been made to ensure the accuracy of the specifications contained in this manual, due to our policy of continuous development, CAL Controls Ltd reserves the right to make changes without prior notice.

CUSTOMER FEEDBACK

It is CAL Controls aim to provide the best possible service to our customers. Feedback from our customers is therefore very important to ensure that we can make continual improvements to our products and services. Should you wish to register any issues with CAL please e-mail us at support@cal-controls.co.uk or via the 'contact us' section of our web site at www.cal-controls.co.uk. Title your e-mail comments as 'Registered customer feedback' or 'Registered customer complaint'.

Alternatively you can contact us on tel: +44 (0)1462 436161 or fax: +44 (0)1462 451801

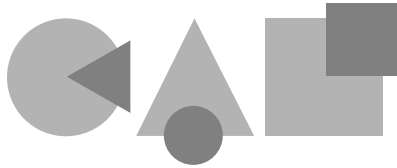

CAL Controls



CAL Controls Ltd

Bury Mead Road, Hitchin, Herts, SG5 1RT. UK
Tel: + 44 (0)1462-436161 Fax: + 44 (0)1462-451801
email: support@cal-controls.co.uk
<http://www.cal-controls.com>

CAL Controls Inc

1117 S.Milwaukee Avenue, Libertyville, IL 60048. USA
Tel: (847) 680-7080 Fax: (847) 816-6852
email: sales@cal-controls.com
<http://www.cal-controls.com>